

# YPÄJÄ 2024

MARATHON INFO  
CAI2\*-H1; CAI2\*-P1; CAI2\*-P2  
National Class 11; 12

(03.08.2024)

Course Designer – Kristaps Caune (LAT)





# YPÄJÄ 2024

## Marathon Section Times

CAI2\*-H1  
National Class 11; 12  
(03.08.2024)

### Horses

Section	Distance	Speed	Minimum Time	Time Allowed	Maximum Time	Compulsory Turning Flags
<b>In Harness Inspection</b>						
Section A	6330 m	13 km/h	27 min 13 sec	29 min 13 sec	35 min 04 sec	1 - 4
Neutral Zone	3 min					
Rest	10 min					
Warm Up Obstacle	max. 2 min					
Section B 01-07	6930 m	14 km/h	26 min 42 sec	29 min 42 sec	59 min 24 sec	1 - 13
Cool Down In Harness Examination	Track		10 min		15 min	



# YPÄJÄ 2024

## Marathon Section Times

CAI2\*-P1; CAI2\*-P2  
National Class 11; 12  
(03.08.2024)

### Ponies

Section	Distance	Speed	Minimum Time	Time Allowed	Maximum Time	Compulsory Turning Flags
<b>In Harness Inspection</b>						
Section A	6330 m	12 km/h	29 min 39 sec	31 min 39 sec	37 min 59 sec	1 - 4
Neutral Zone	3 min					
Rest	10 min					
Warm Up Obstacle	max. 2 min					
Section B 01-07	6930 m	13 km/h	29 min 00 sec	32 min 00 sec	64 min 00 sec	1 - 13
Cool Down In Harness Examination	Track		10 min		15 min	

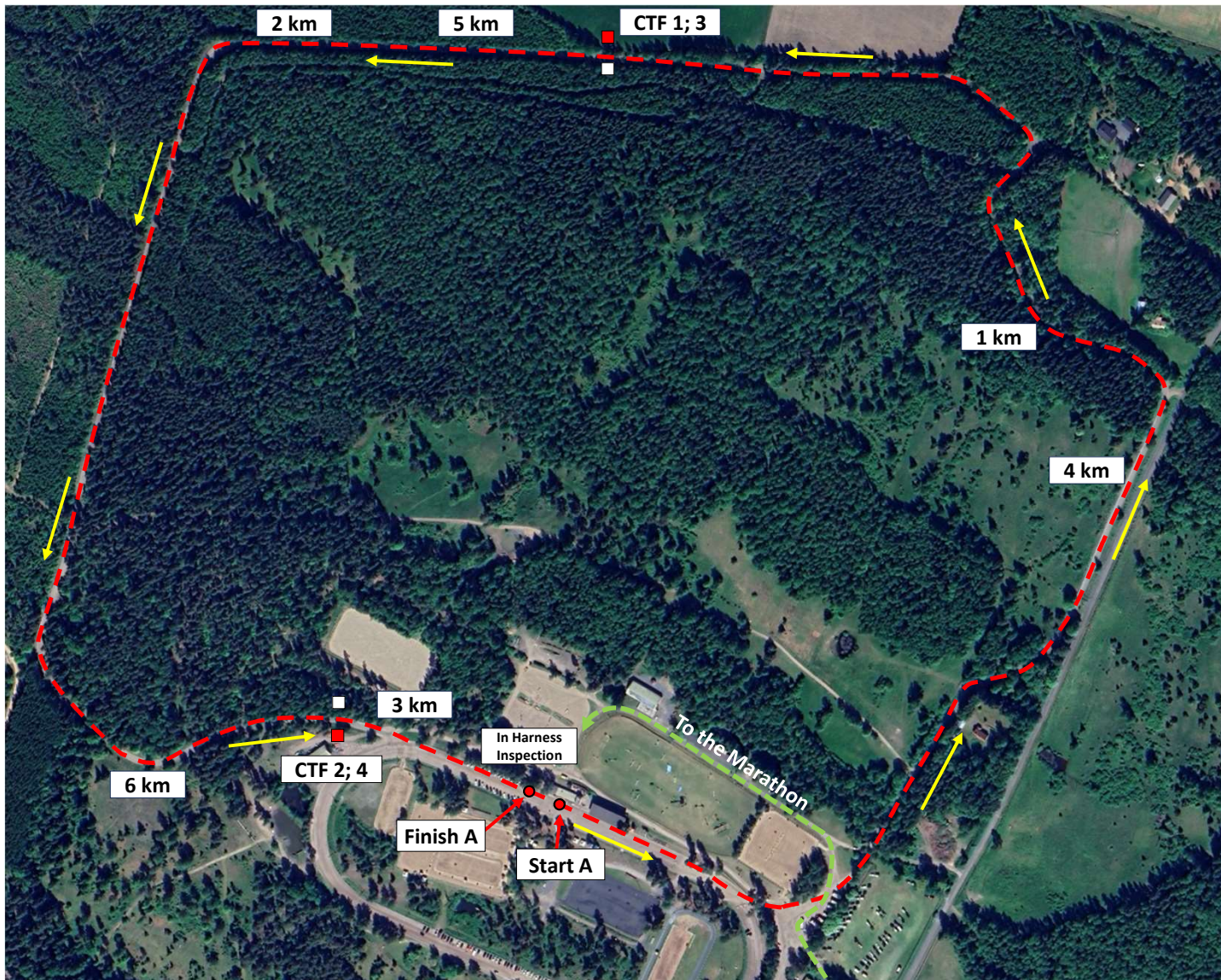

# YPÄJÄ 2024

CAI2\*-H1; CAI2\*-P1; CAI2\*-P2  
National Class 11; 12

## Section A

6330 m

Start A	4 km
1 km	CTF 3
CTF 1	5 km
2 km	6 km
CTF 2	CTF 4
3 km	<b>Finish A</b>
	<b>6330 m</b>

CD KRISTAPS CAUNE

# Section B (6930 m)

CAI2\*-H1; CAI2\*-P1; CAI2\*-P2  
National Class 11; 12

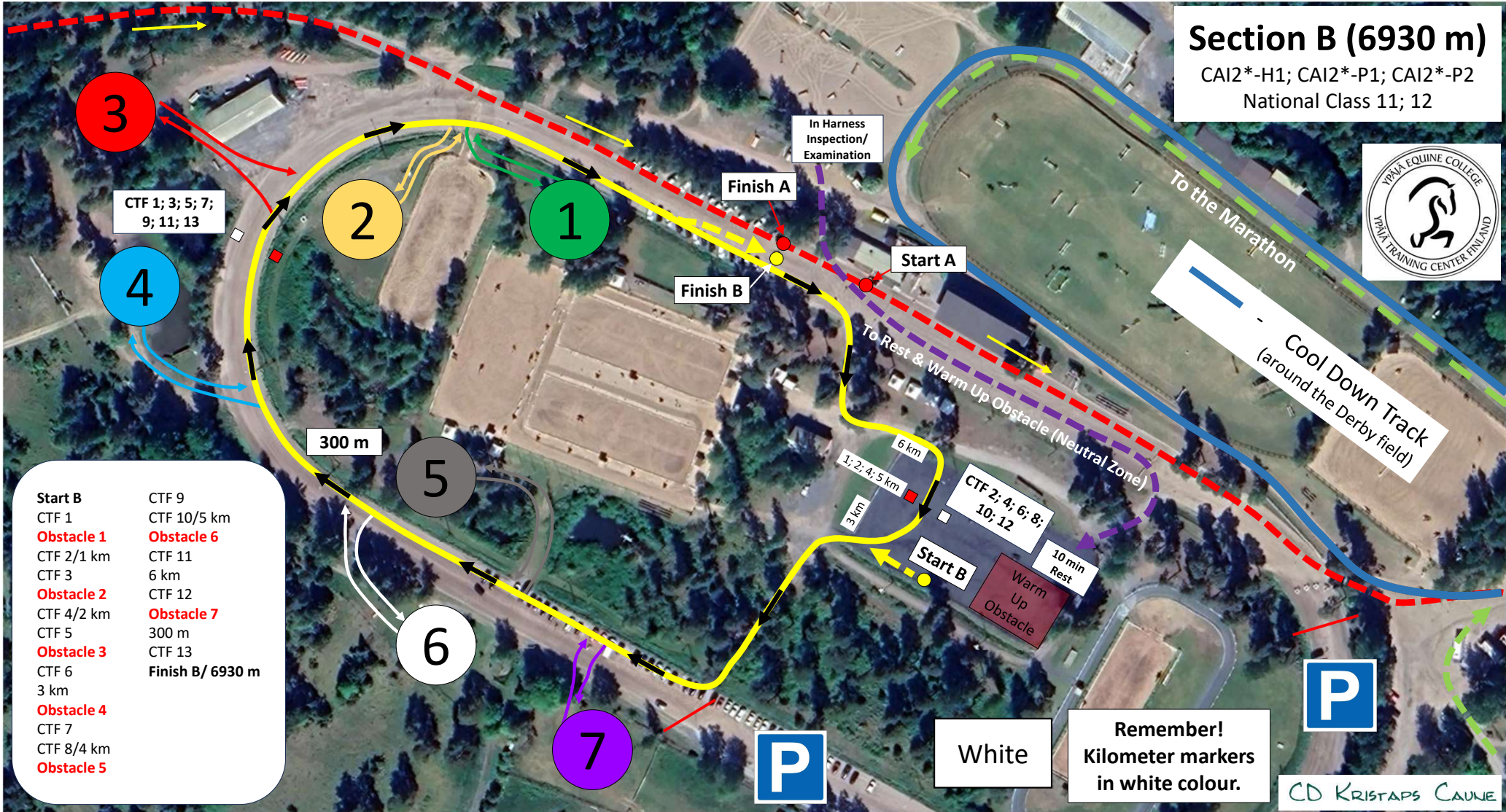

- |                   |                   |
|-------------------|-------------------|
| <b>Start B</b>    | CTF 9             |
| CTF 1             | CTF 10/5 km       |
| <b>Obstacle 1</b> | <b>Obstacle 6</b> |
| CTF 2/1 km        | CTF 11            |
| CTF 3             | 6 km              |
| <b>Obstacle 2</b> | CTF 12            |
| CTF 4/2 km        | <b>Obstacle 7</b> |
| CTF 5             | 300 m             |
| <b>Obstacle 3</b> | CTF 13            |
| CTF 6             | Finish B/ 6930 m  |
| 3 km              |                   |
| <b>Obstacle 4</b> |                   |
| CTF 7             |                   |
| CTF 8/4 km        |                   |
| <b>Obstacle 5</b> |                   |

White

**Remember!**  
Kilometer markers  
in white colour.

CD KRISTAPS CAUNE

CAI2\*-H1; CAI2\*-P1; CAI2\*-P2 Gates – A-F  
National Class 11; 12 Gates – A-F

Ypäjän Osuuspankki

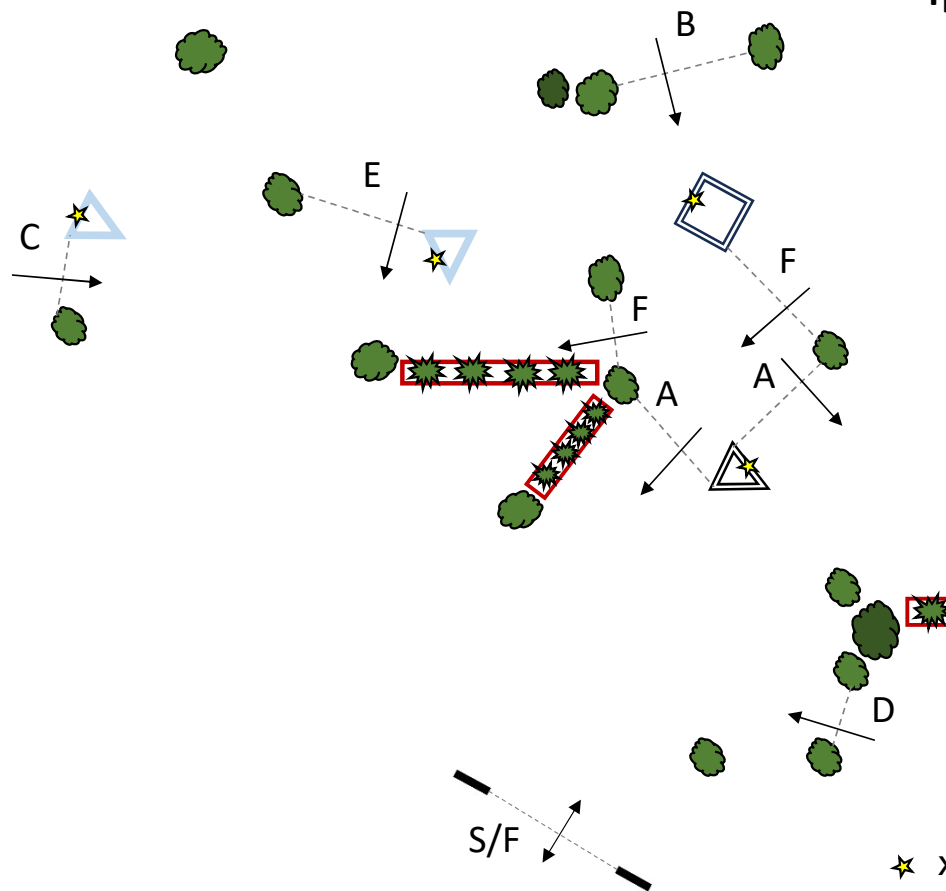

★ x 4 - dislodgeable elements

CD KRISTAPS CAUNE

CAI2\*-H1; CAI2\*-P1; CAI2\*-P2 Gates – A-F  
National Class 11; 12 Gates – A-F

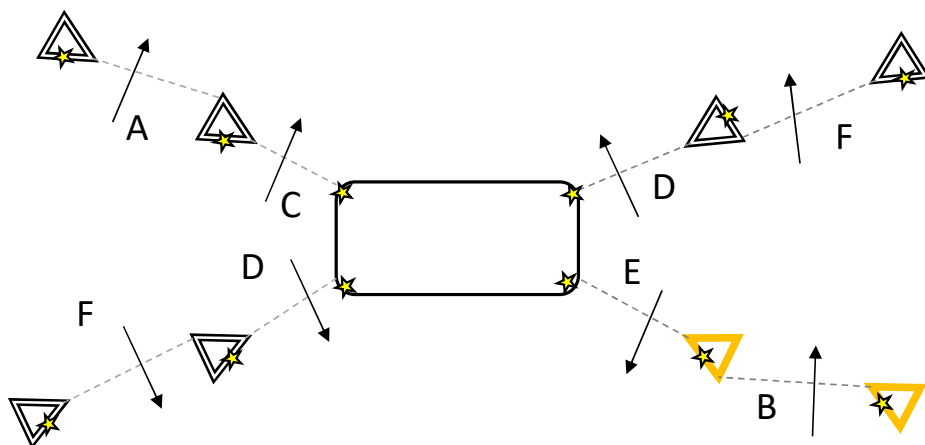
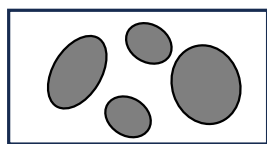

Equine College

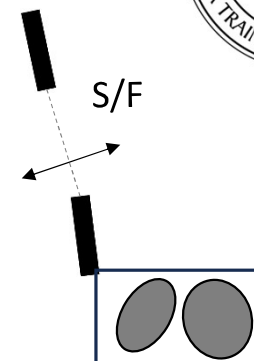

★ x 12 - dislodgeable elements

CD KRISTAPS CAUNE

CAI2\*-H1; CAI2\*-P1; CAI2\*-P2 Gates – A-F  
National Class 11; 12 Gates – A-F

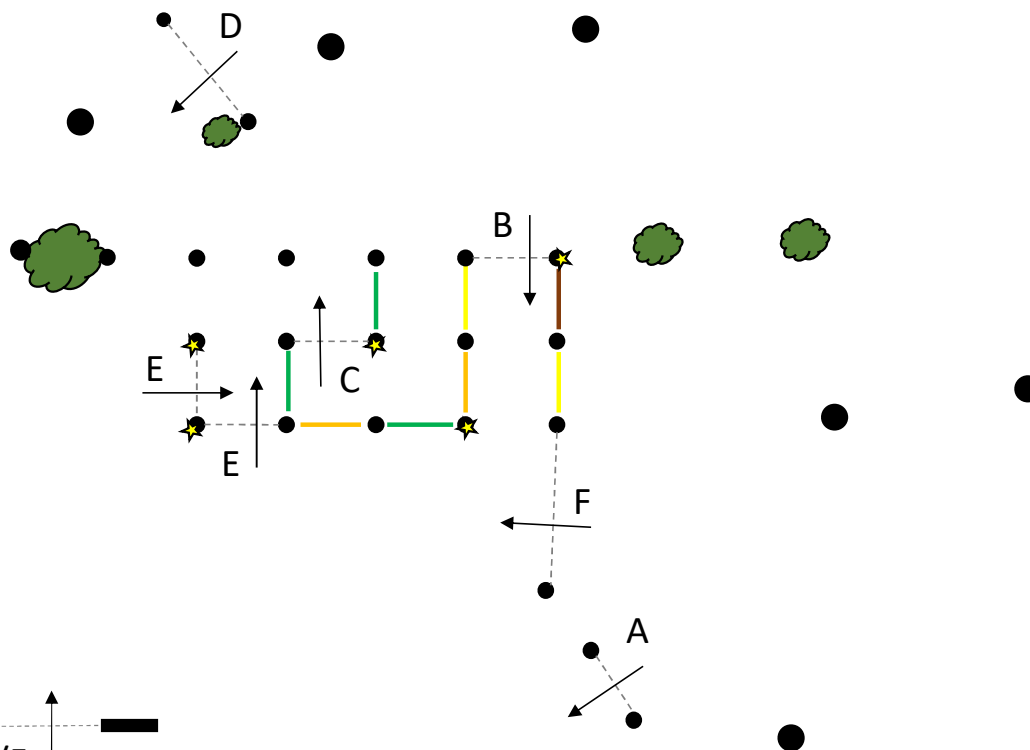

★ x 5 - dislodgeable elements

CD KRISTAPS CAUNE



CAI2\*-H1; CAI2\*-P1; CAI2\*-P2 Gates – A-F  
National Class 11; 12 Gates – A-F



VaTu ry

4

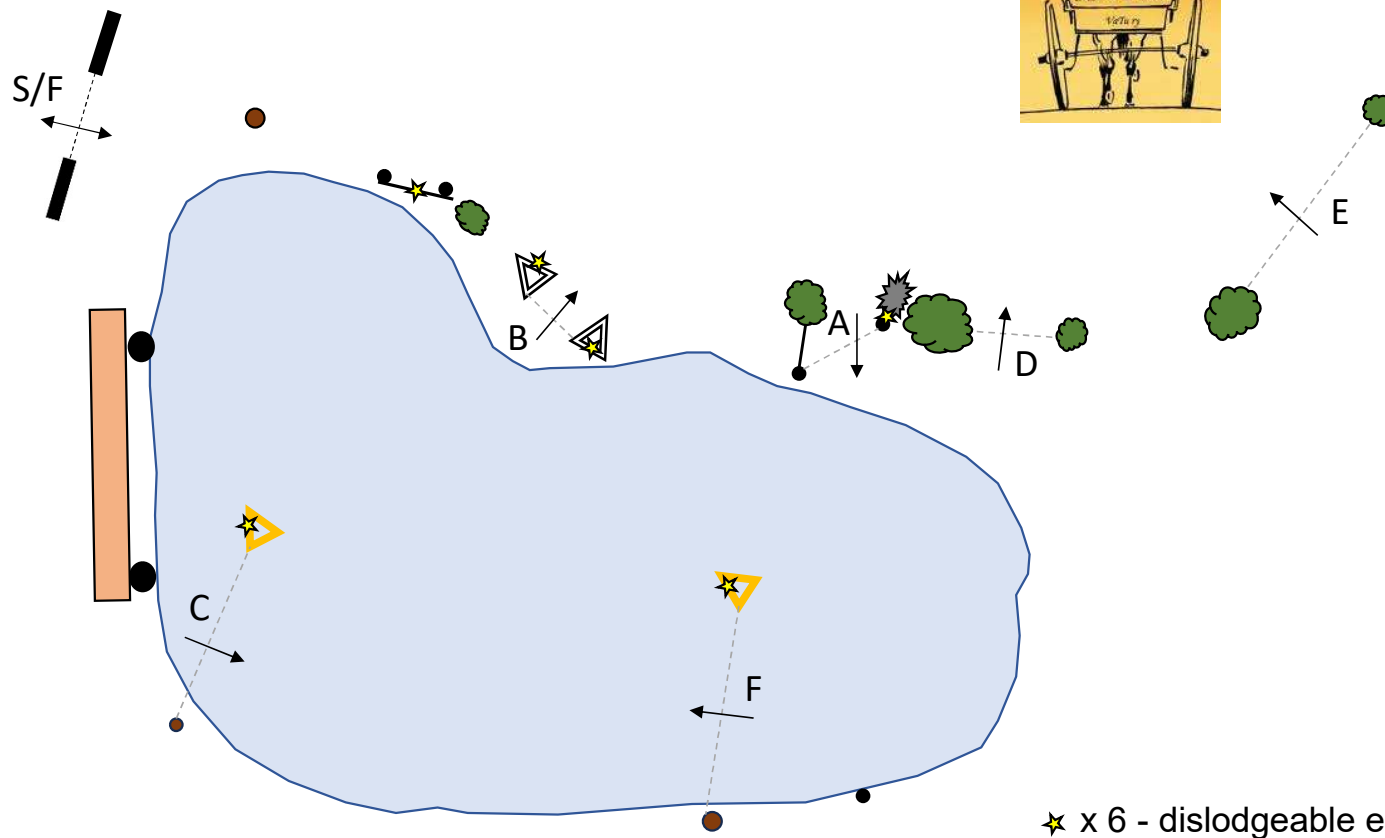

CAI2\*-H1; CAI2\*-P1; CAI2\*-P2 Gates – A-F  
National Class 11; 12 Gates – A-F

Equestrian Sport Museum

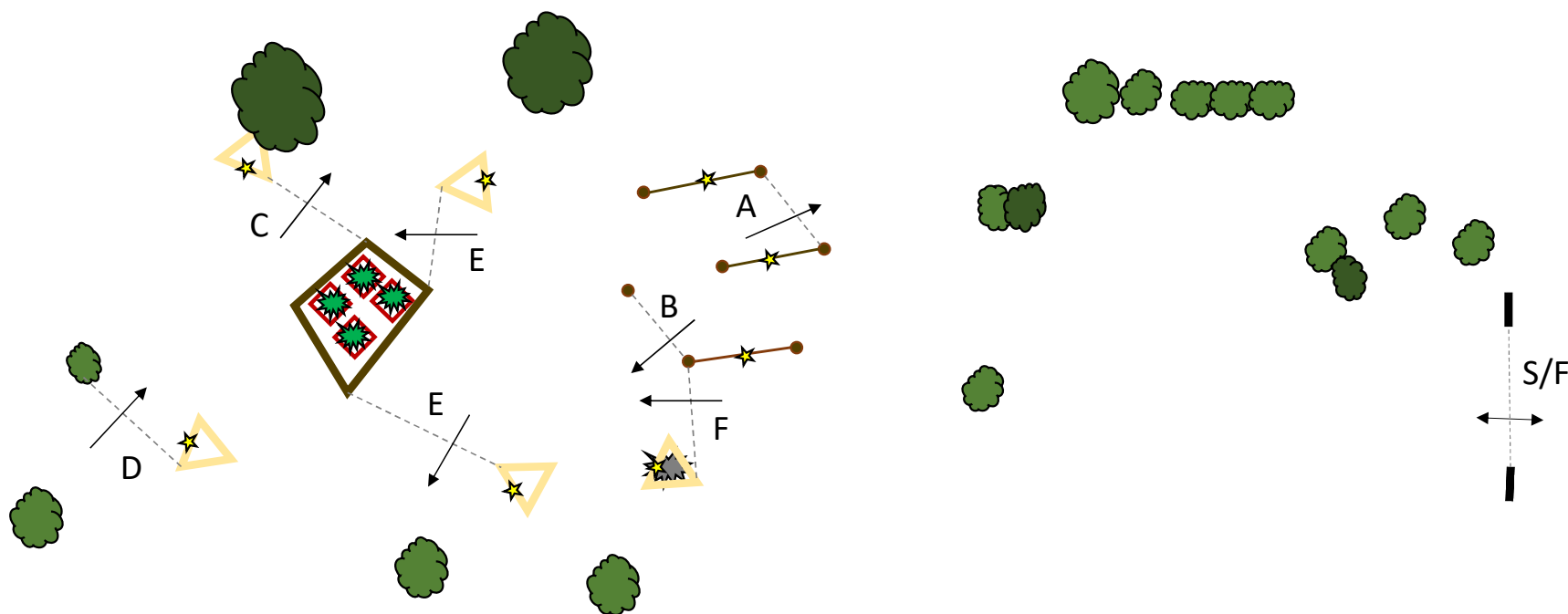

★ x 8 - dislodgeable elements

CD KRISTAPS CAUNE

CAI2\*-H1; CAI2\*-P1; CAI2\*-P2 Gates – A-F  
 National Class 11; 12 Gates – A-F

Equine College

6

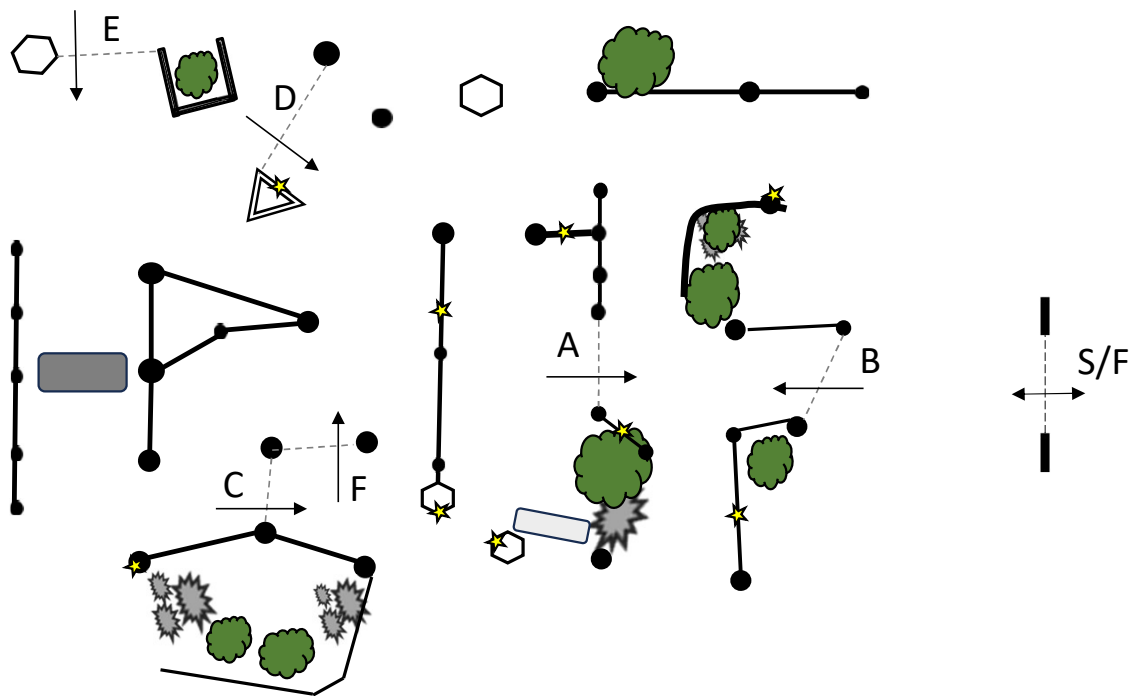

★ x 9 - dislodgeable elements

CD KRISTAPS CAUNE

CAI2\*-H1; CAI2\*-P1; CAI2\*-P2 Gates – A-F  
National Class 11; 12 Gates – A-F

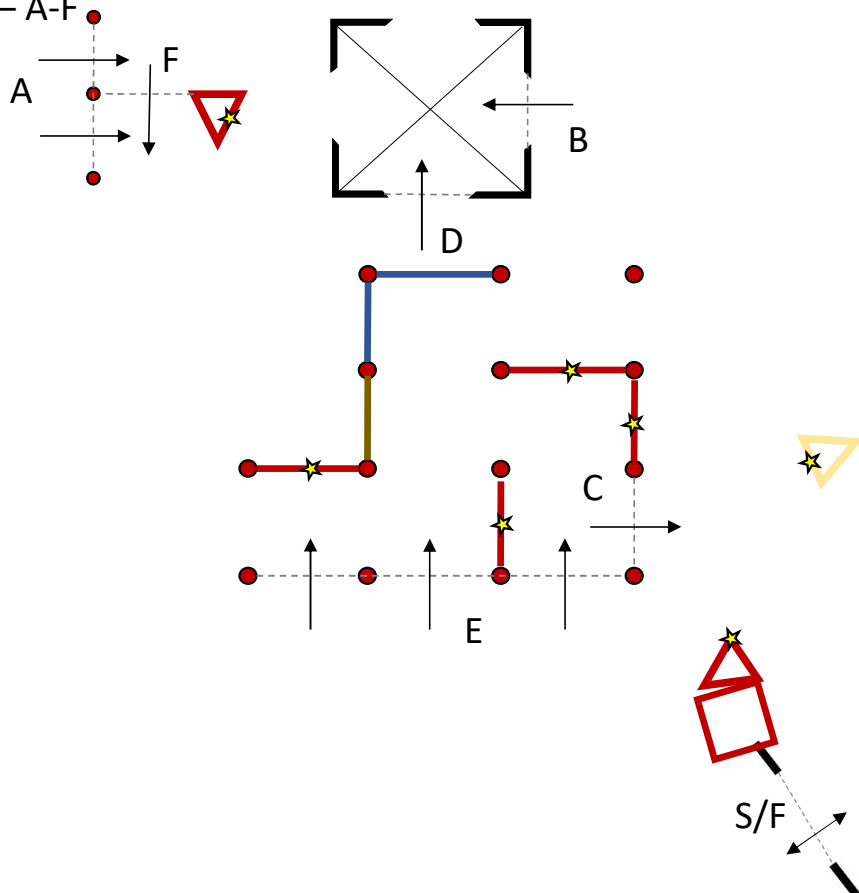

★ x 7 - dislodgable elements