

# YPÄJÄ 2024

## MARATHON INFO National Class 10

(03.08.2024)

Course Designer – Kristaps Caune (LAT)





# YPÄJÄ 2024

## Marathon Section Times

National Class 10

(03.08.2024)

### Horses

Section	Distance	Speed	Minimum Time	Time Allowed	Maximum Time	Compulsory Turning Flags
<b>In Harness Inspection</b>						
<b>Section A</b>	4955 m	12 km/h	<b>22 min 47 sec</b>	<b>24 min 47 sec</b>	<b>29 min 44 sec</b>	1 - 4
<b>Neutral Zone</b>	3 min					
<b>Rest</b>	10 min					
<b>Warm Up Obstacle</b>	max. 2 min					
<b>Section B 01-05; 07</b>	5890 m	12.5 km/h	<b>25 min 17 sec</b>	<b>28 min 17 sec</b>	<b>56 min 34 sec</b>	1 - 11
<b>Cool Down In Harness Examination</b>	Track		10 min		15 min	



# YPÄJÄ 2024

## Marathon Section Times

National Class 10  
(03.08.2024)

### Ponies

Section	Distance	Speed	Minimum Time	Time Allowed	Maximum Time	Compulsory Turning Flags
<b>In Harness Inspection</b>						
<b>Section A</b>	4955 m	11 km/h	<b>25 min 02 sec</b>	<b>27 min 02 sec</b>	<b>32 min 26 sec</b>	1 - 4
<b>Neutral Zone</b>	3 min					
<b>Rest</b>	10 min					
<b>Warm Up Obstacle</b>	max. 2 min					
<b>Section B 01-05; 07</b>	5890 m	11.5 km/h	<b>27 min 47 sec</b>	<b>30 min 44 sec</b>	<b>61 min 28 sec</b>	1 - 11
<b>Cool Down In Harness Examination</b>	Track		10 min		15 min	

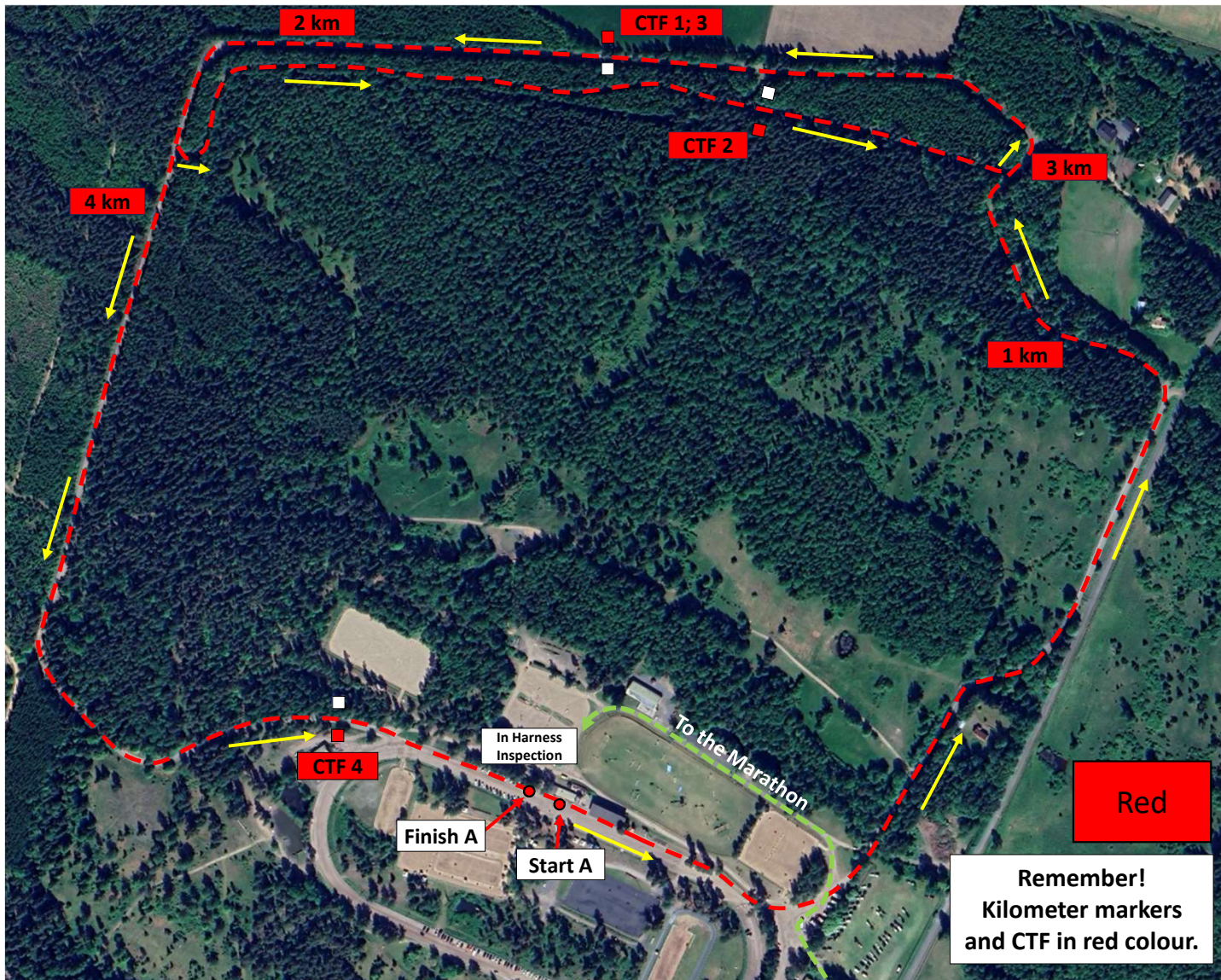

# YPÄJÄ 2024

National Class 10

## Section A

4955 m

Start A	3 km
1 km	CTF 3
CTF 1	4 km
2 km	CTF 4
CTF 2	Finish A
	4955 m

CD KRISTAPS CAUNE



# Section B (5890 m)

National Class 10

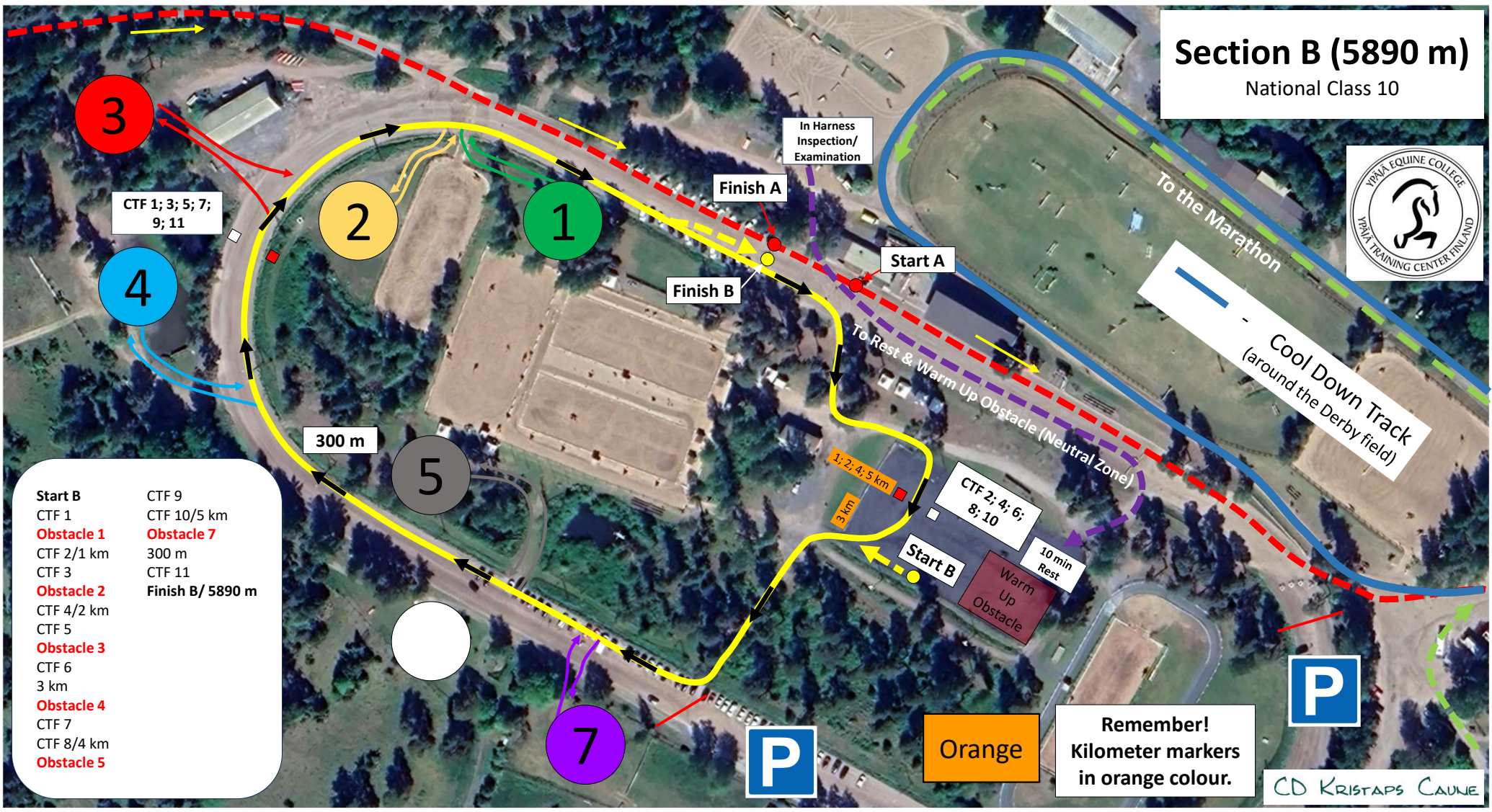

- |                   |                         |
|-------------------|-------------------------|
| <b>Start B</b>    | CTF 9                   |
| CTF 1             | CTF 10/5 km             |
| <b>Obstacle 1</b> | <b>Obstacle 7</b>       |
| CTF 2/1 km        | 300 m                   |
| CTF 3             | CTF 11                  |
| <b>Obstacle 2</b> | <b>Finish B/ 5890 m</b> |
| CTF 4/2 km        |                         |
| CTF 5             |                         |
| <b>Obstacle 3</b> |                         |
| CTF 6             |                         |
| 3 km              |                         |
| <b>Obstacle 4</b> |                         |
| CTF 7             |                         |
| CTF 8/4 km        |                         |
| <b>Obstacle 5</b> |                         |



Orange

**Remember!**  
Kilometer markers  
in orange colour.



CD KRISTAPS CAUNE

National Class 10 Gates – A-F

Ypäjän Osuuspankki



1

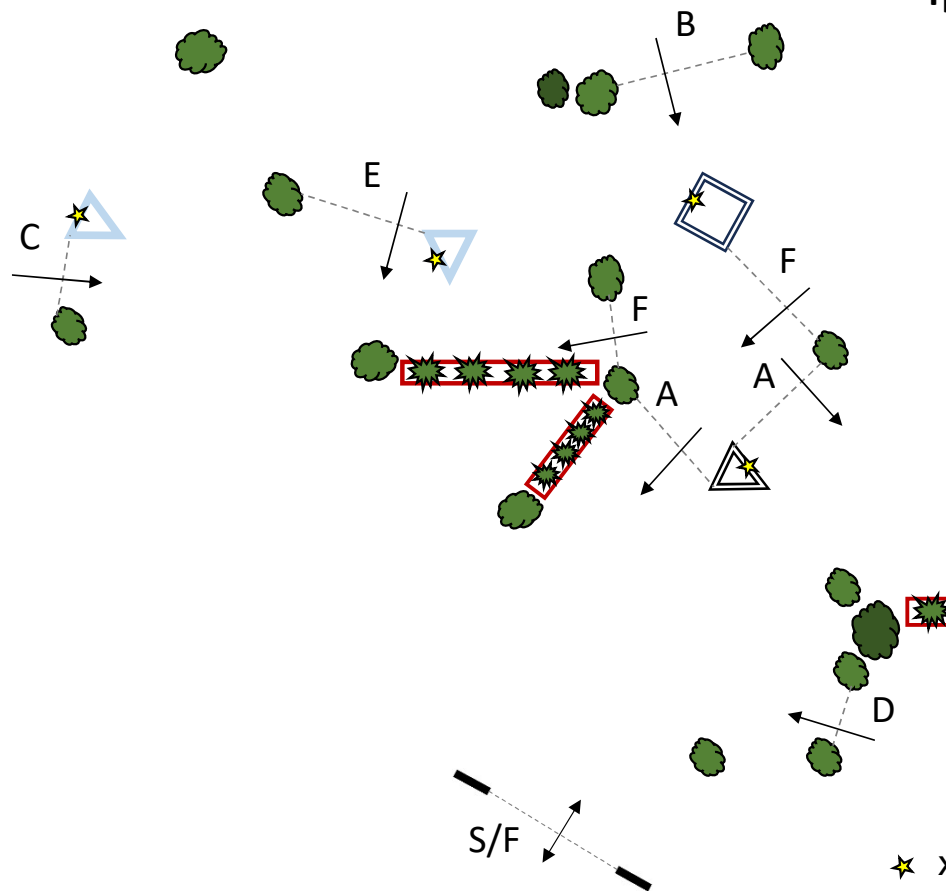

★ x 4 - dislodgeable elements

CD KRISTAPS CAUNE

National Class 10 Gates – A-F

Equine College

2

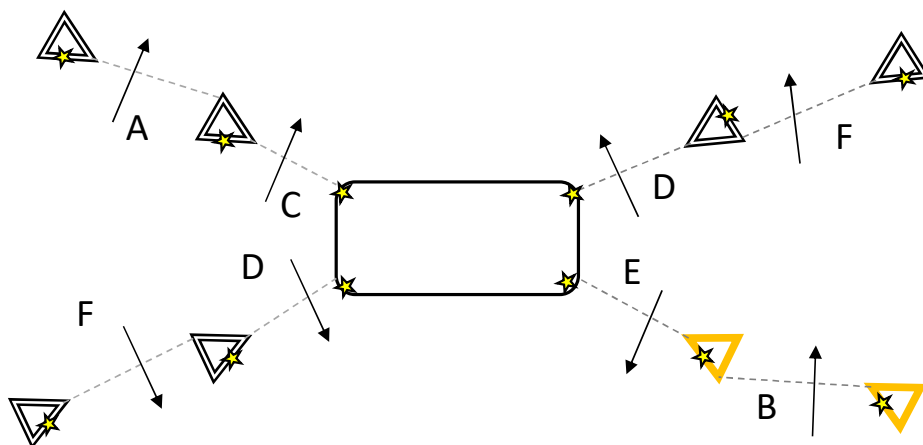
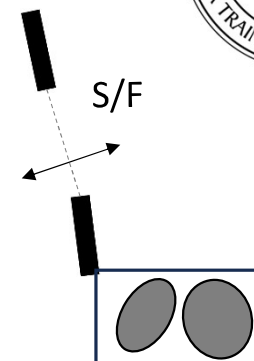
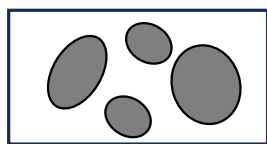

★ x 12 - dislodgeable elements

CD KRISTAPS CAUNE

National Class 10 Gates – A-F

C Rinne **3**

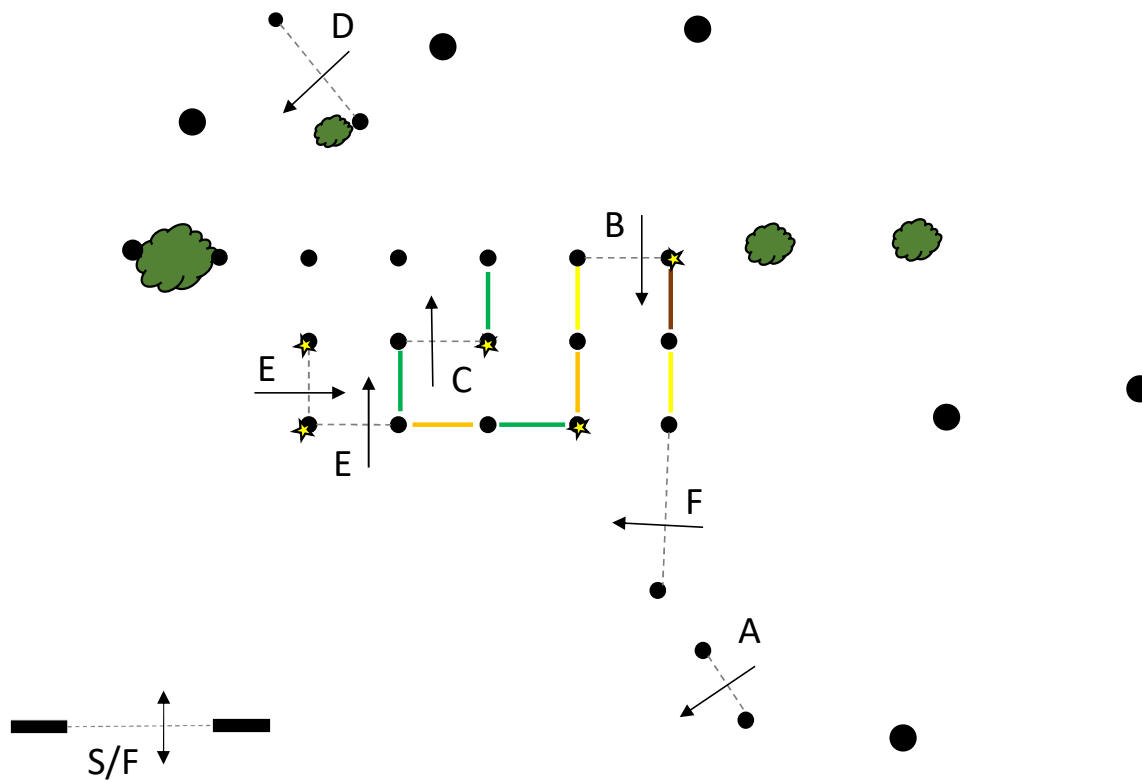

★ x 5 - dislodgeable elements

CD KRISTAPS CAUNE





National Class 10 Gates – A-F

Equestrian Sport Museum

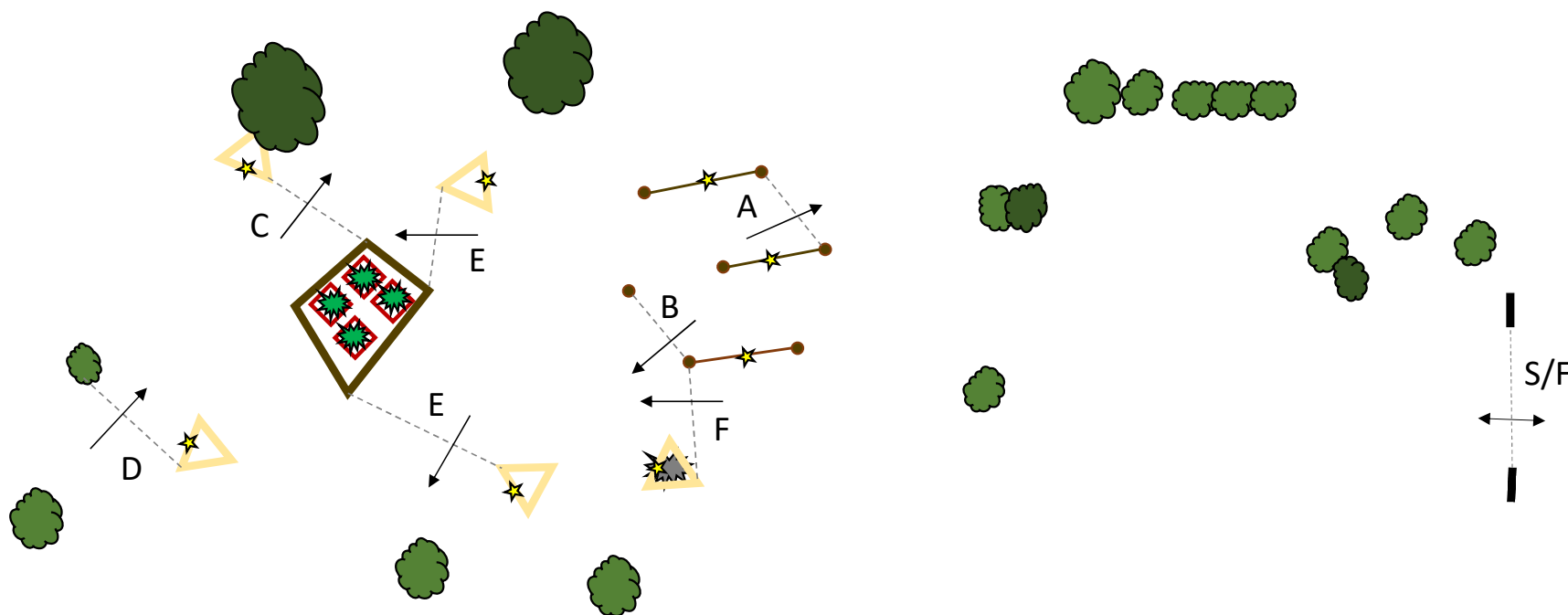

★ x 8 - dislodgeable elements

CD KRISTAPS CAUNE

National Class 10 Gates – A-F

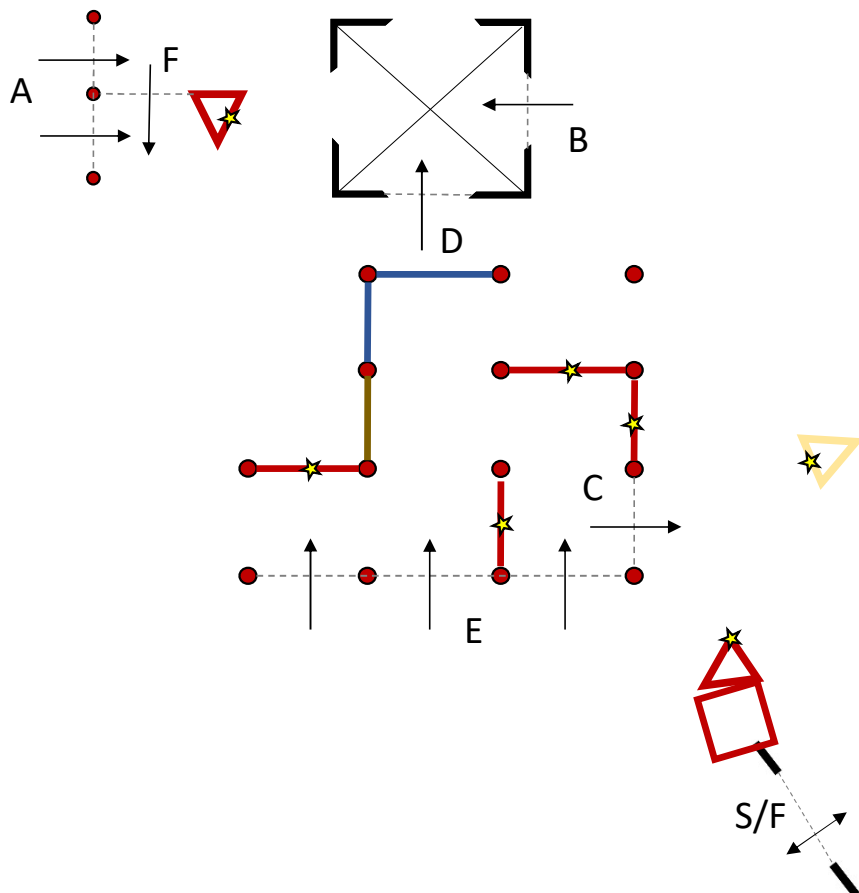

★ x 7 - dislodgable elements

CD KRISTAPS CAUNE