

# YPÄJÄ 2024

MARATHON INFO  
National Class 2; 6; 8

(03.08.2024)

Course Designer – Kristaps Caune (LAT)





# YPÄJÄ 2024

## Marathon Section Times

National Class 8  
(03.08.2024)

### Horses

Section	Distance	Speed	Minimum Time	Time Allowed	Maximum Time	Compulsory Turning Flags
<b>In Harness Inspection</b>						
<b>Section A</b>	3140 m	11 km/h	<b>15 min 08 sec</b>	<b>17 min 08 sec</b>	<b>20 min 34 sec</b>	1 - 2
<b>Neutral Zone</b>	3 min					
<b>Rest</b>	10 min					
<b>Warm Up Obstacle</b>	max. 2 min					
<b>Section B O1; O2; O4; O5; O7</b>	4760 m	11.5 km/h	<b>21 min 51 sec</b>	<b>24 min 51 sec</b>	<b>49 min 42 sec</b>	1 - 9
<b>Cool Down In Harness Examination</b>	Track		10 min		15 min	



# YPÄJÄ 2024

## Marathon Section Times

National Class 6  
(03.08.2024)

### Ponies

Section	Distance	Speed	Minimum Time	Time Allowed	Maximum Time	Compulsory Turning Flags
<b>In Harness Inspection</b>						
Section A	3140 m	10 km/h	16 min 51 sec	18 min 51 sec	22 min 37 sec	1 - 2
Neutral Zone	3 min					
Rest	10 min					
Warm Up Obstacle	max. 2 min					
Section B O1; O2; O4; O5; O7	4760 m	10.5 km/h	24 min 12 sec	27 min 12 sec	54 min 24 sec	1 - 9
Cool Down In Harness Examination	Track		10 min		15 min	



# YPÄJÄ 2024

## Marathon Section Times

National Class 2  
(03.08.2024)

### Ponies

Section	Distance	Speed	Minimum Time	Time Allowed	Maximum Time	Compulsory Turning Flags
<b>In Harness Inspection</b>						
Controlled Warm Up	Area		18 min	20 min	24 min	
Neutral Zone	2 min					
Rest	5 min					
Warm Up Obstacle	max. 2 min					
Section B O1; O2; O4; O5; O7	4760 m	9.5 km/h	27 min 04 sec	30 min 04 sec	60 min 08 sec	1 - 9
Cool Down In Harness Examination	Track		10 min		15 min	

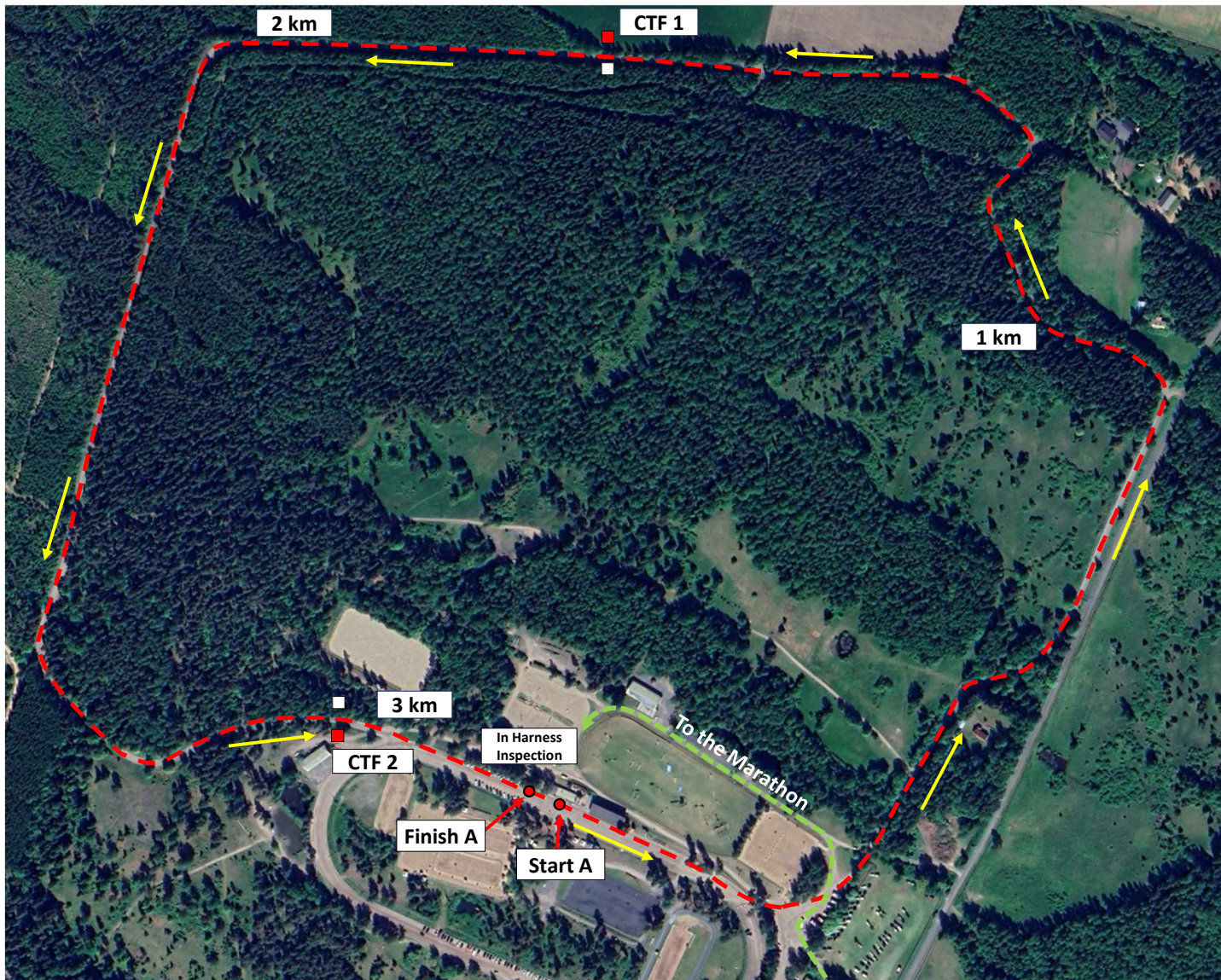

# YPÄJÄ 2024

National Class 6; 8

## Section A

3140 m

Start A	CTF 2
1 km	3 km
CTF 1	Finish A
2 km	3140 m

CD KRISTAPS CAUNE



# YPÄJÄ 2024

National Class 2

## Controlled Warm Up

CD KRISTAPS CAUNE

# Section B (4760 m)

National Class 2; 6; 8

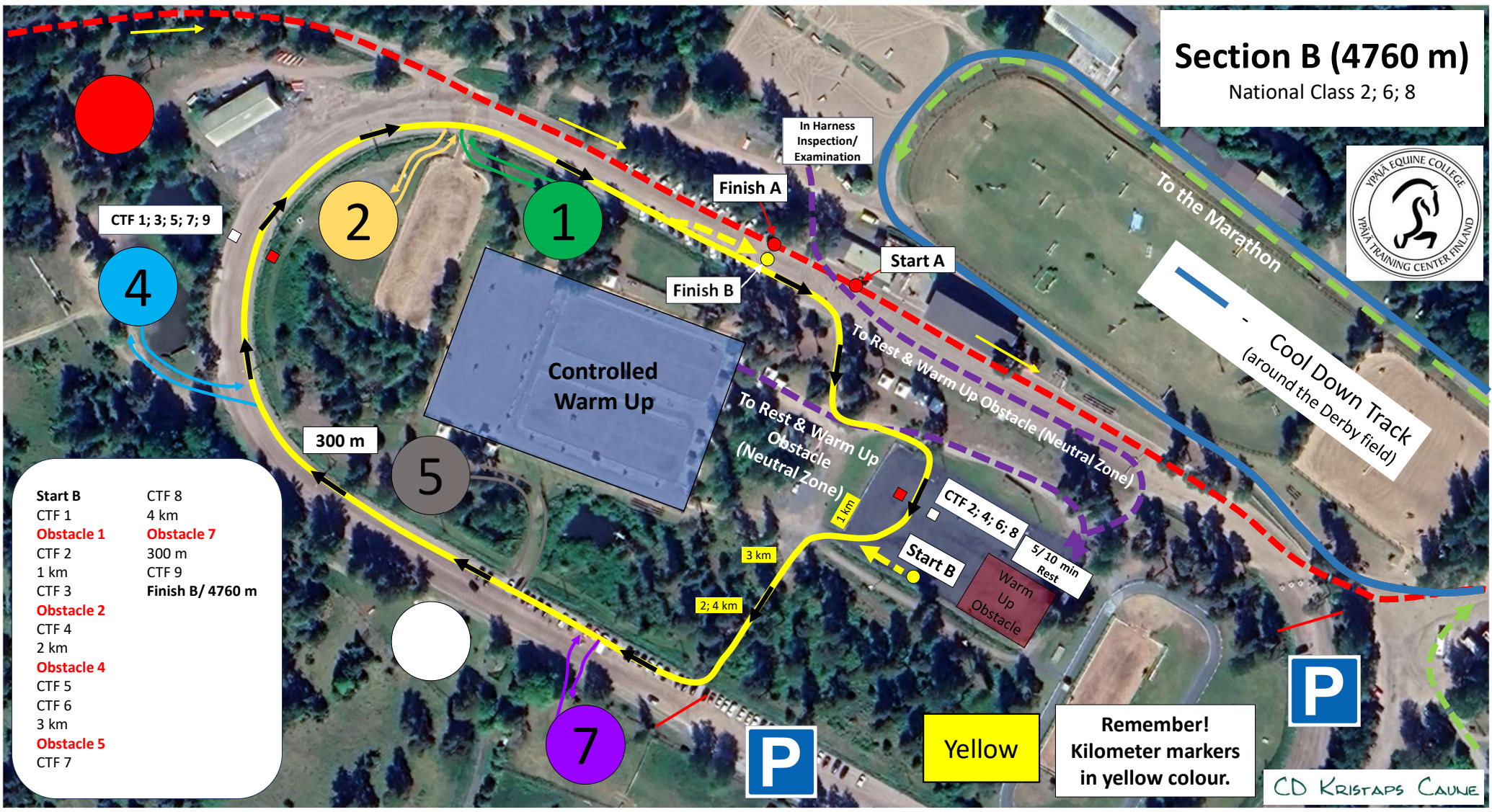

- |                   |                   |
|-------------------|-------------------|
| Start B           | CTF 8             |
| CTF 1             | 4 km              |
| <b>Obstacle 1</b> | <b>Obstacle 7</b> |
| CTF 2             | 300 m             |
| 1 km              | CTF 9             |
| CTF 3             | Finish B/ 4760 m  |
| <b>Obstacle 2</b> |                   |
| CTF 4             |                   |
| 2 km              |                   |
| <b>Obstacle 4</b> |                   |
| CTF 5             |                   |
| CTF 6             |                   |
| 3 km              |                   |
| <b>Obstacle 5</b> |                   |
| CTF 7             |                   |

**Remember!**  
Kilometer markers  
in yellow colour.

CD KRISTAPS CAUNE

National Class 2; 6; 8 Gates – A-E

Ypäjän Osuuspankki



1

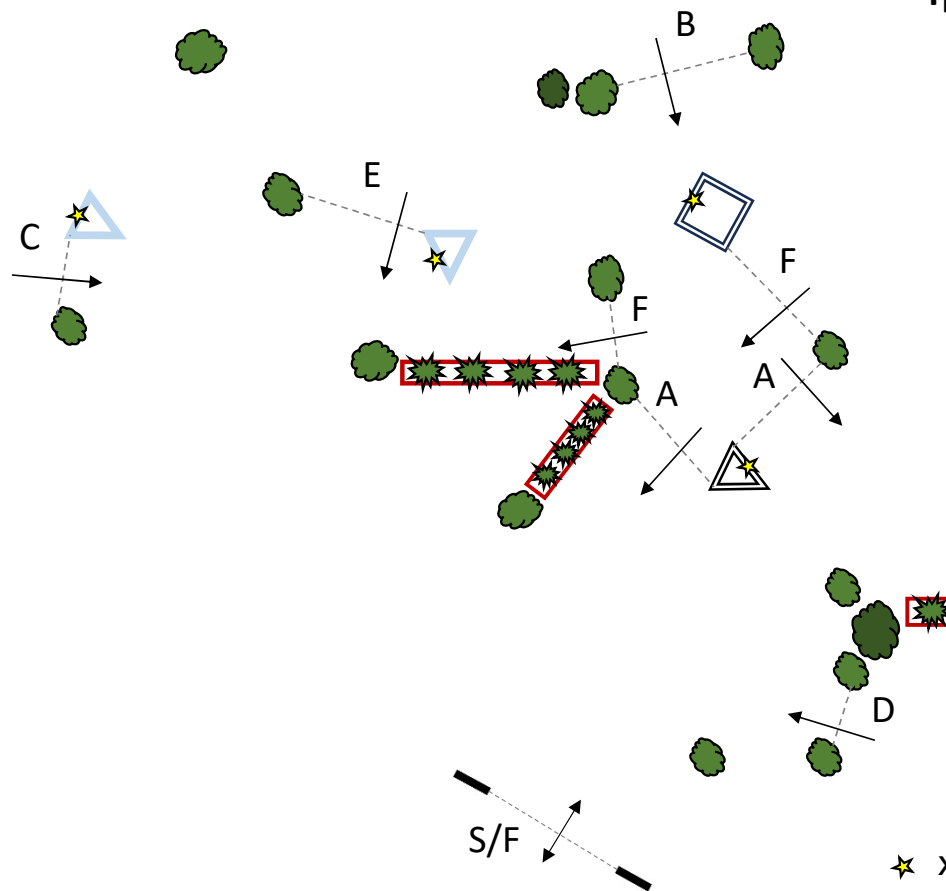

★ x 4 - dislodgeable elements

CD KRISTAPS CAUNE



National Class 2; 6; 8 Gates – A-E

Equine College

2

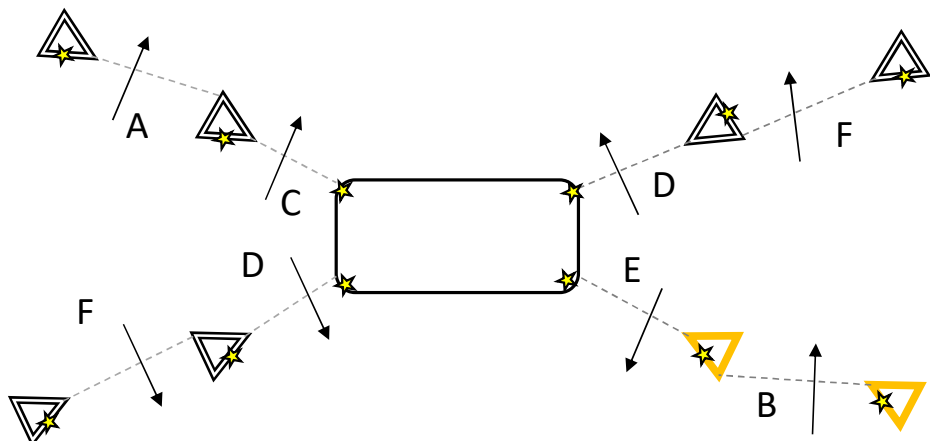
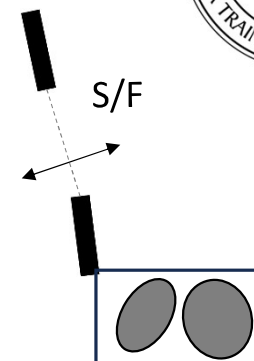
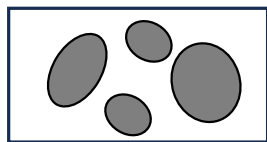

★ x 12 - dislodgeable elements

CD KRISTAPS CAUNE

National Class 2; 6; 8 Gates – A-E



VaTu ry

4

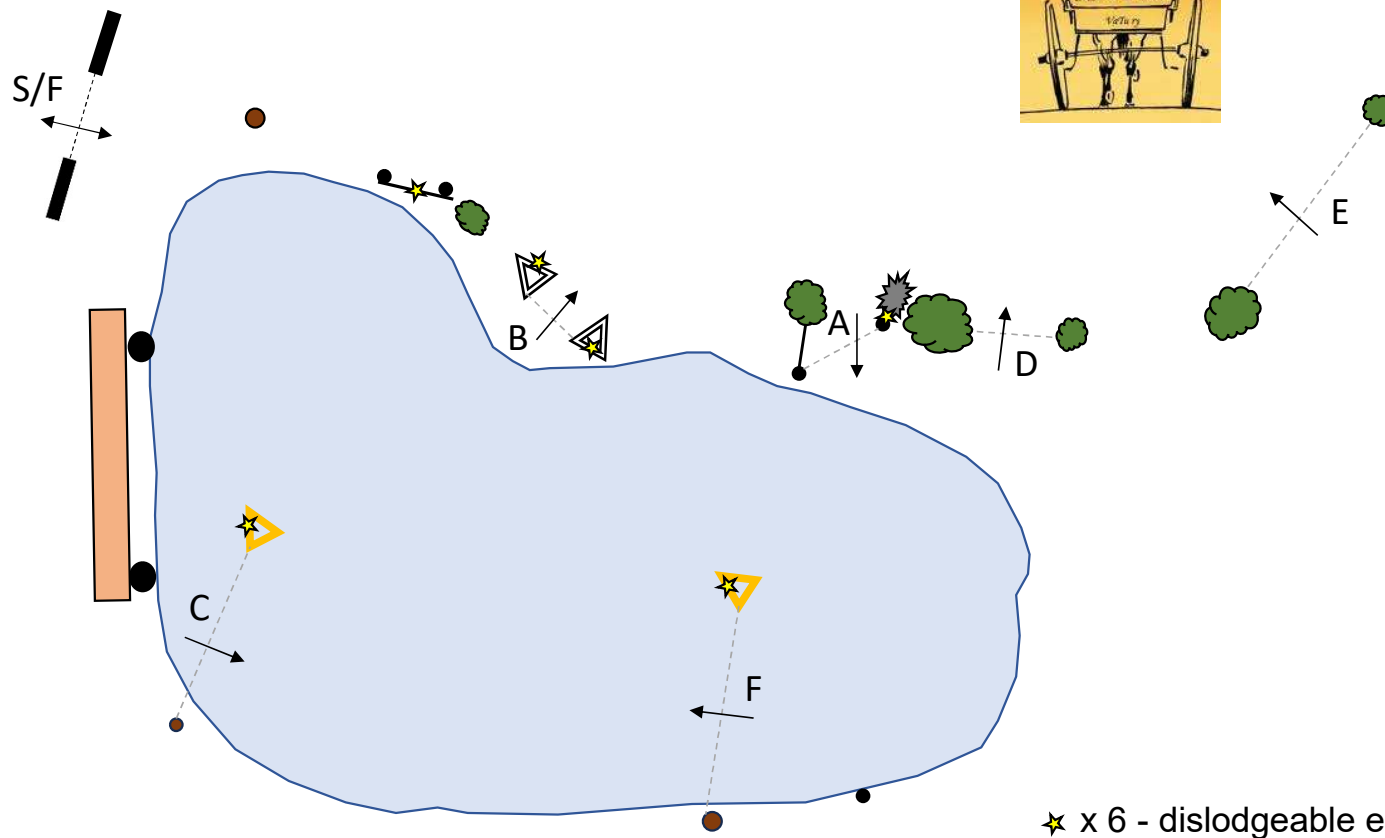

CD KRISTAPS CAUNE

National Class 2; 6; 8 Gates – A-E

Equestrian Sport Museum

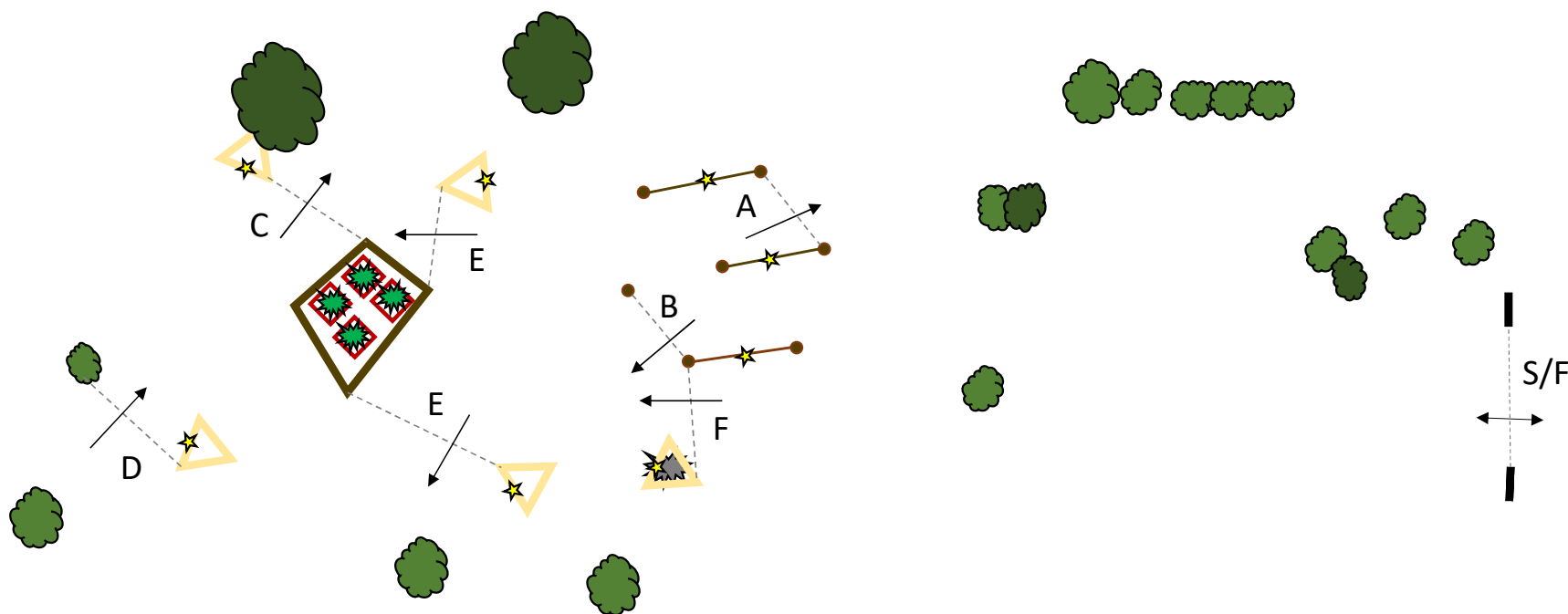

★ x 8 - dislodgeable elements

CD KRISTAPS CAUNE

YPÄJÄ 2024

# OBSTACLE 7

03.08.2024.

National Class 2; 6; 8 Gates – A-E

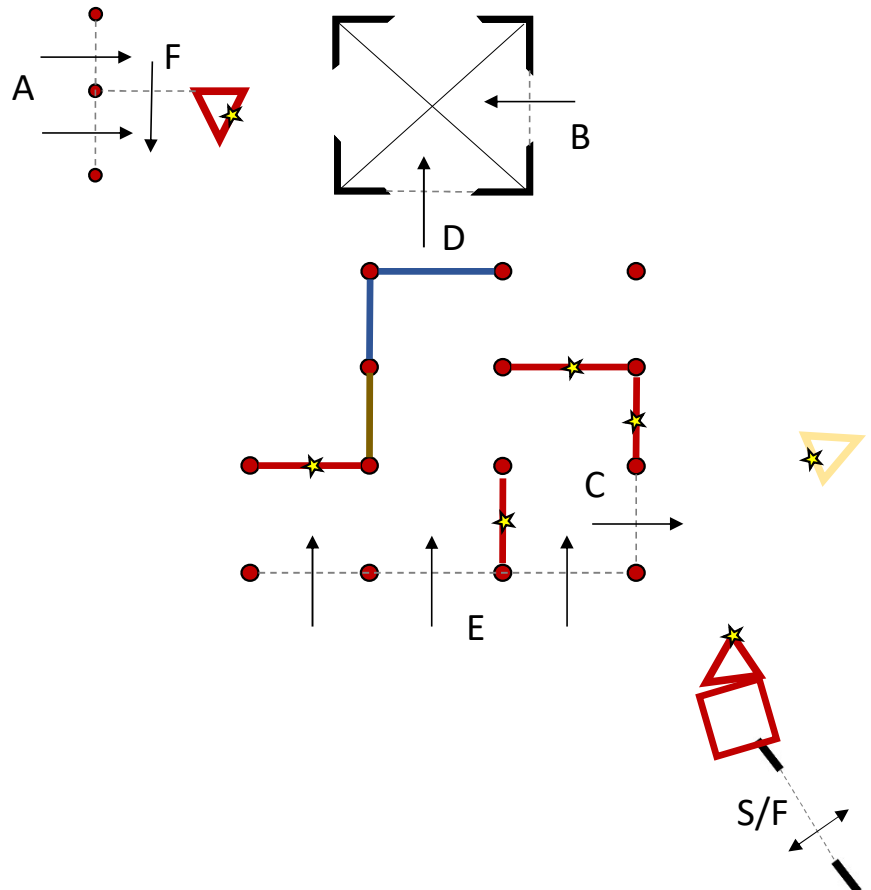

★ x 7 - dislodgable elements

CD KRISTAPS CAUNE