

YPÄJÄ 2024

MARATHON INFO
National Class 3; 7; 9

(03.08.2024)

Course Designer – Kristaps Caune (LAT)





YPÄJÄ 2024

Marathon Section Times

National Class 9
(03.08.2024)

Horses

Section	Distance	Speed	Minimum Time	Time Allowed	Maximum Time	Compulsory Turning Flags
In Harness Inspection						
Section A	3140 m	11 km/h	15 min 08 sec	17 min 08 sec	20 min 34 sec	1 - 2
Neutral Zone	3 min					
Rest	10 min					
Warm Up Obstacle	max. 2 min					
Section B 01-05; 07	5730 m	11.5 km/h	26 min 54 sec	29 min 54 sec	59 min 48 sec	1 - 11
Cool Down In Harness Examination	Track		10 min		15 min	



YPÄJÄ 2024

Marathon Section Times

National Class 7
(03.08.2024)

Ponies

Section	Distance	Speed	Minimum Time	Time Allowed	Maximum Time	Compulsory Turning Flags
In Harness Inspection						
Section A	3140 m	10 km/h	16 min 51 sec	18 min 51 sec	22 min 37 sec	1 - 2
Neutral Zone	3 min					
Rest	10 min					
Warm Up Obstacle	max. 2 min					
Section B 01-05; 07	5730 m	10.5 km/h	29 min 45 sec	32 min 45 sec	65 min 30 sec	1 - 11
Cool Down In Harness Examination	Track		10 min		15 min	



YPÄJÄ 2024

Marathon Section Times

National Class 3
(03.08.2024)

Ponies

Section	Distance	Speed	Minimum Time	Time Allowed	Maximum Time	Compulsory Turning Flags
In Harness Inspection						
Controlled Warm Up	Area		18 min	20 min	24 min	
Neutral Zone	2 min					
Rest	5 min					
Warm Up Obstacle	max. 2 min					
Section B 01-05; 07	5730 m	10 km/h	31 min 23 sec	34 min 23 sec	68 min 46 sec	1 - 11
Cool Down In Harness Examination	Track		10 min		15 min	

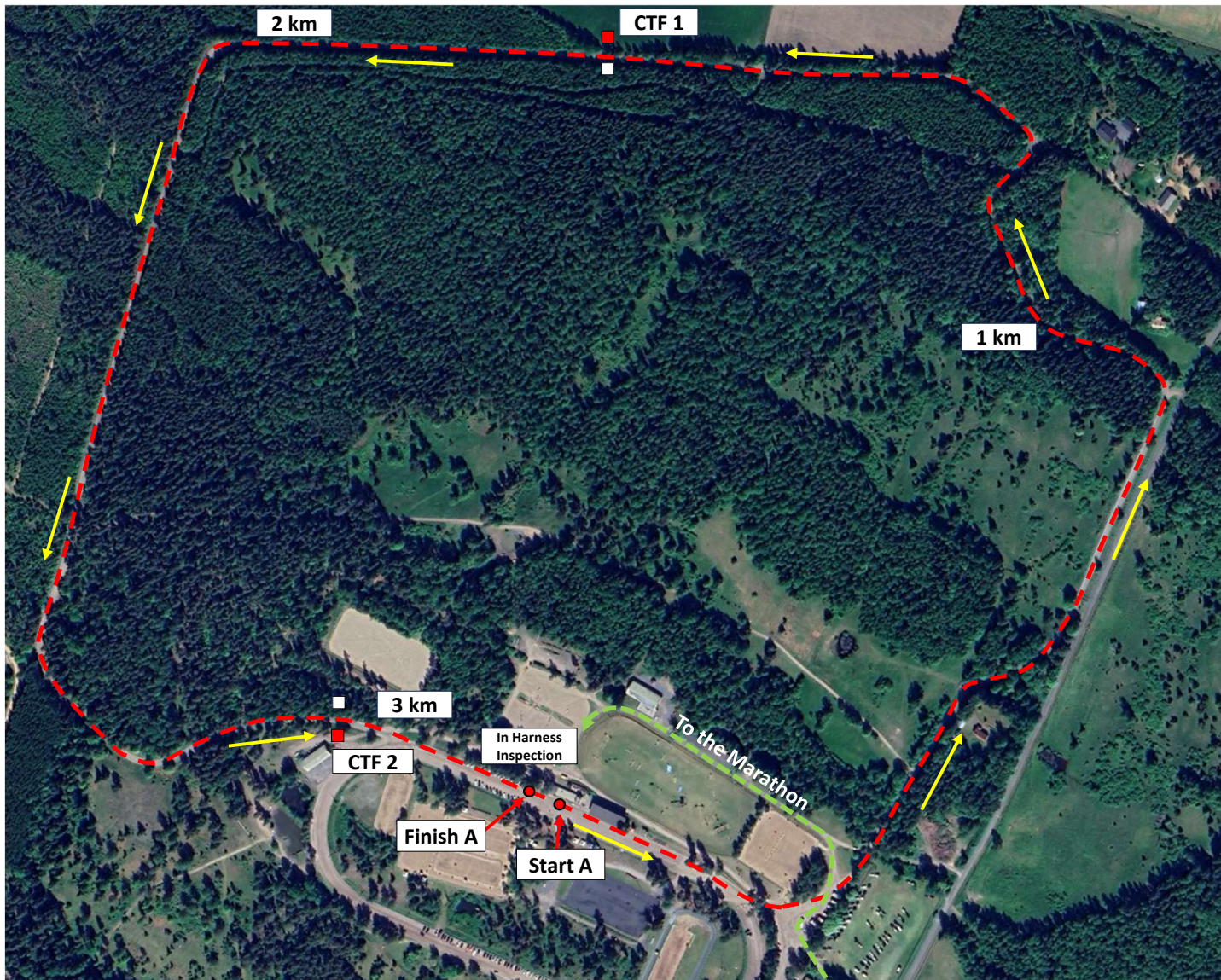

YPÄJÄ 2024

National Class 7; 9

Section A

3140 m

Start A	CTF 2
1 km	3 km
CTF 1	Finish A
2 km	3140 m

CD KRISTAPS CAUNE

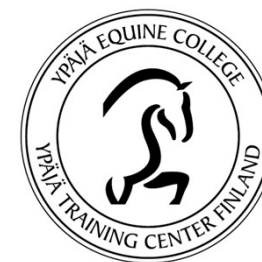

YPÄJÄ 2024

National Class 3

Controlled Warm Up

CD KRISTAPS CAUNE

Section B (5730 m)

National Class 3; 7; 9

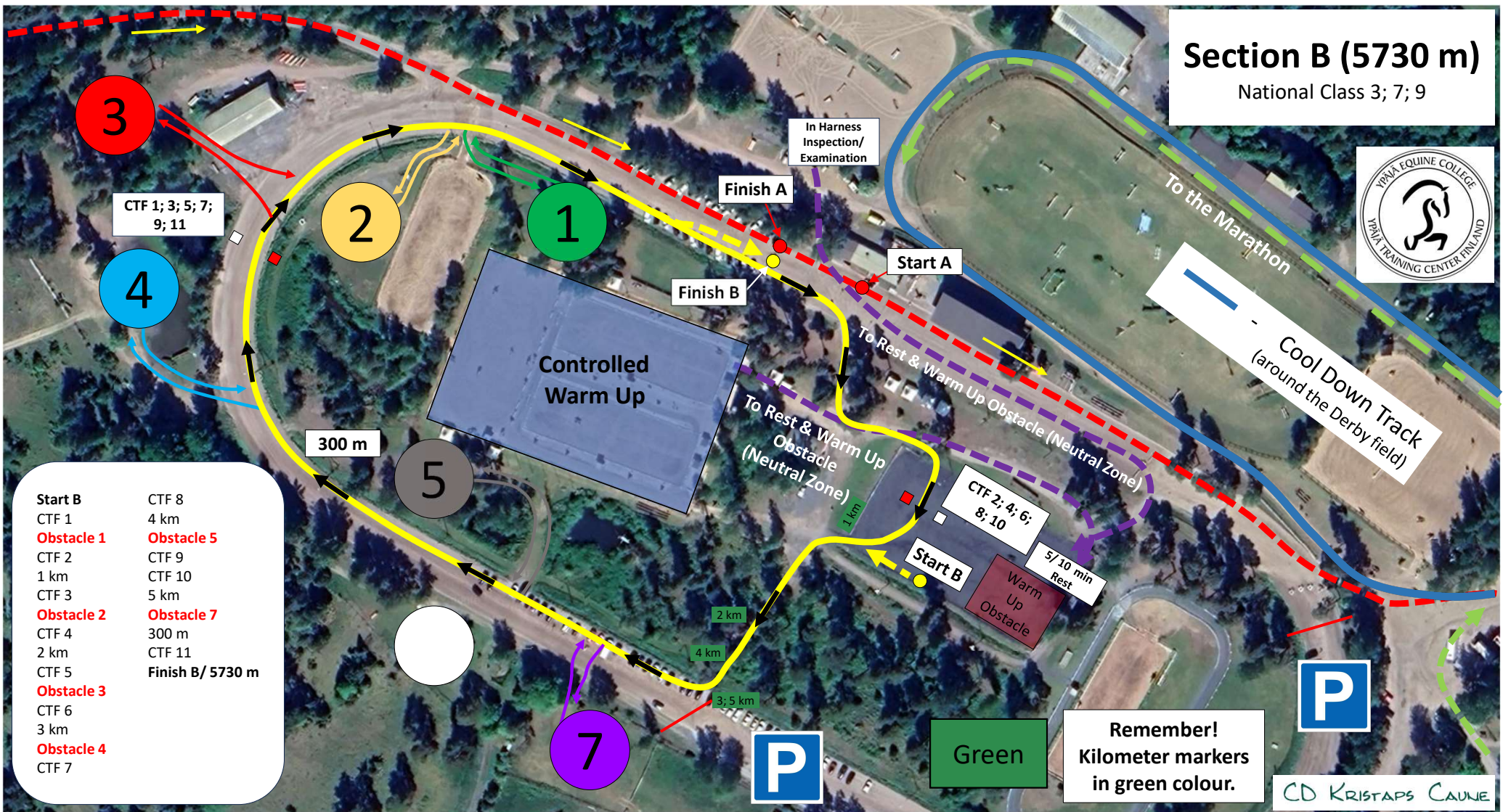

- | | |
|-------------------|-------------------|
| Start B | CTF 8 |
| CTF 1 | 4 km |
| Obstacle 1 | Obstacle 5 |
| CTF 2 | CTF 9 |
| 1 km | CTF 10 |
| CTF 3 | 5 km |
| Obstacle 2 | Obstacle 7 |
| CTF 4 | 300 m |
| 2 km | CTF 11 |
| CTF 5 | Finish B/ 5730 m |
| Obstacle 3 | |
| CTF 6 | |
| 3 km | |
| Obstacle 4 | |
| CTF 7 | |

Remember!
Kilometer markers
in green colour.

CD KRISTAPS CAUNE

National Class 3; 7; 9 Gates – A-E

Ypäjän Osuuspankki

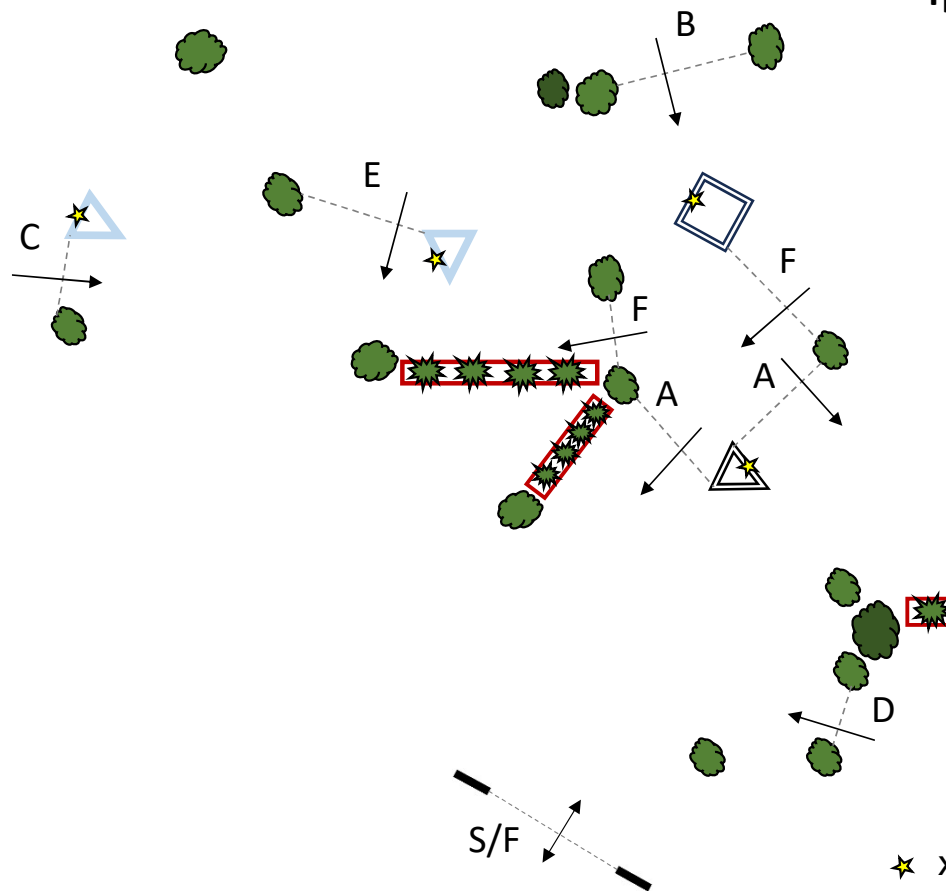

☆ x 4 - dislodgeable elements

CD KRISTAPS CAUNE

National Class 3; 7; 9 Gates – A-E

Equine College

2

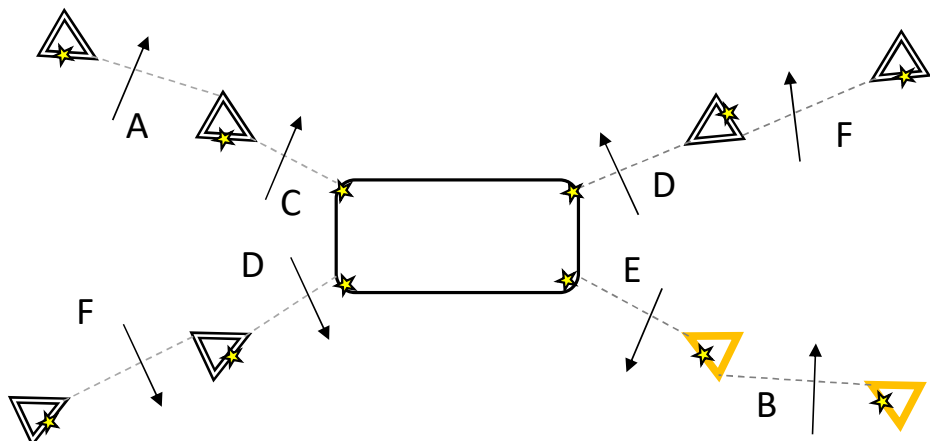
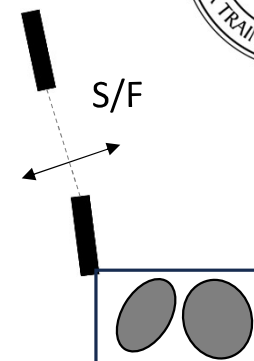
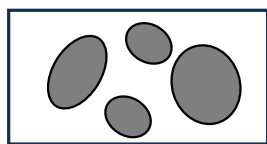

★ x 12 - dislodgeable elements

CD KRISTAPS CAUNE

National Class 3; 7; 9 Gates – A-E

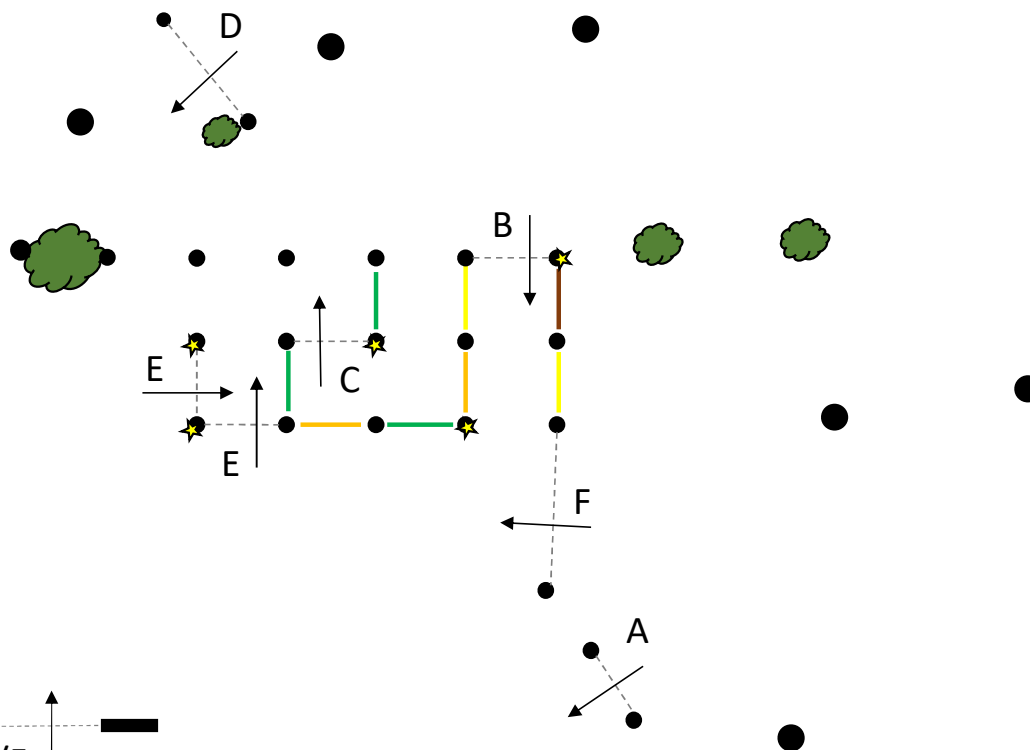

★ x 5 - dislodgeable elements

CD KRISTAPS CAUNE

National Class 3; 7; 9 Gates – A-E



VaTu ry

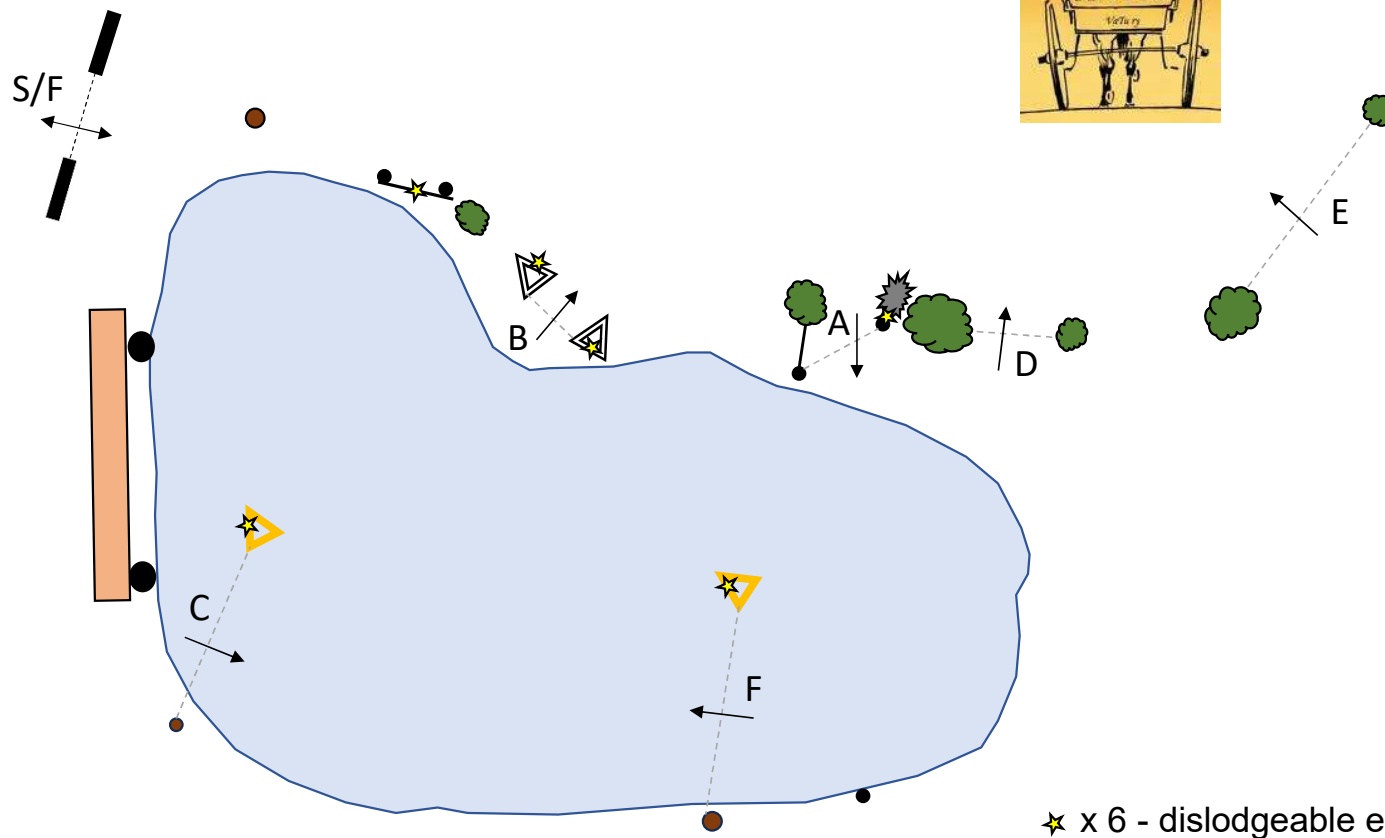

★ x 6 - dislodgeable elements

CD KRISTAPS CAUNE

National Class 3; 7; 9 Gates – A-E

Equestrian Sport Museum

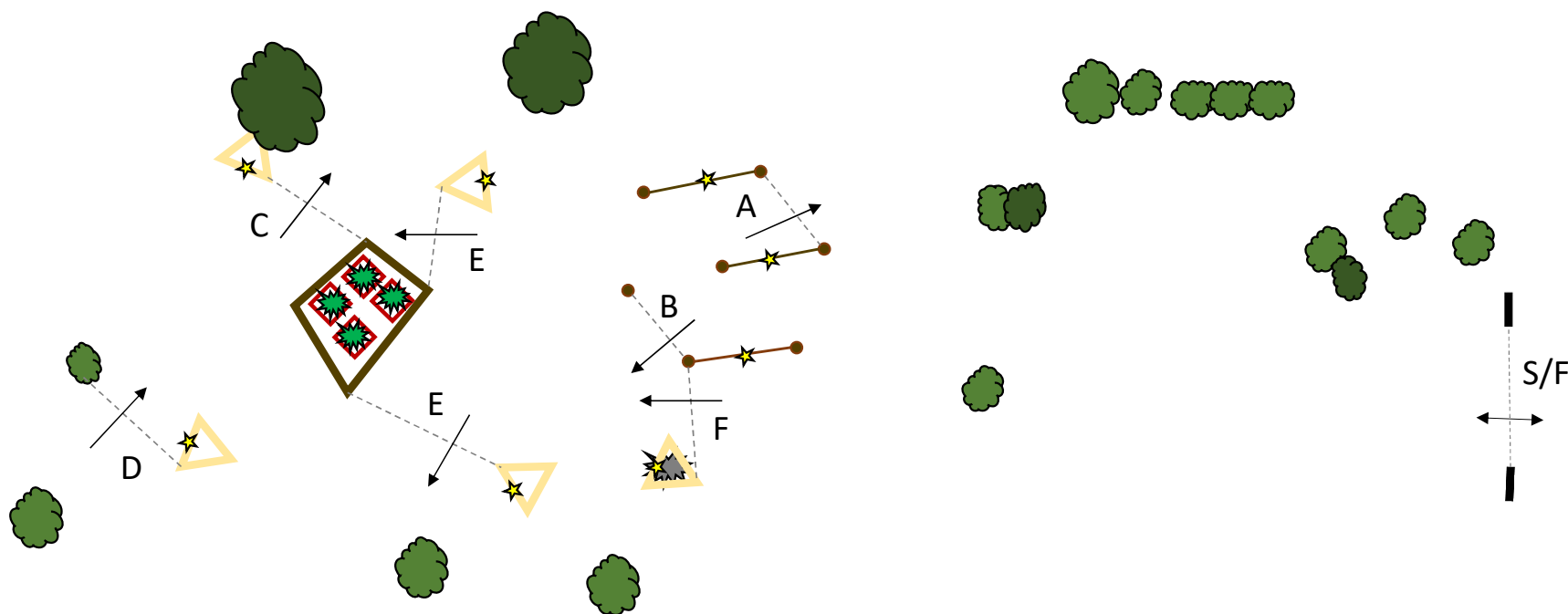

★ x 8 - dislodgeable elements

CD KRISTAPS CAUNE

National Class 3; 7; 9 Gates – A-E

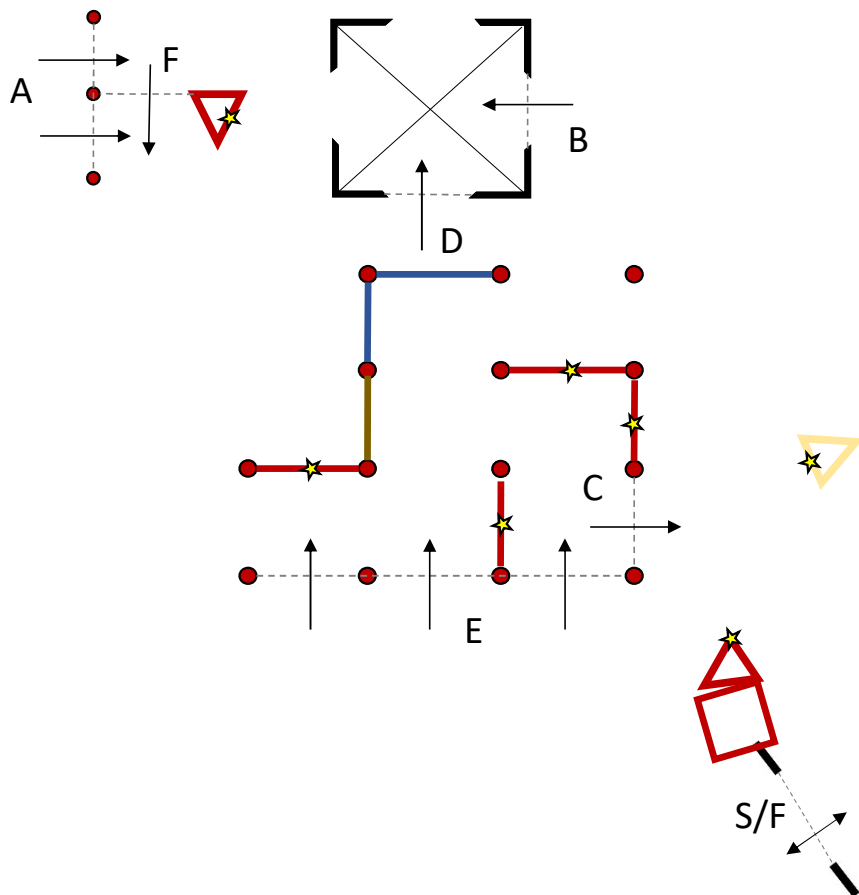

★ x 7 - dislodgable elements

CD KRISTAPS CAUNE